

ZW series

HITACHI

ZW  
370



## WHEEL LOADER

- **Model Code** : ZW370
- **Operating Weight** : 30 770 - 31 510 kg
- **Bucket Capacity** : ISO Heaped : 4.3 - 7.5 m<sup>3</sup>
- **Max. Engine Output** : 268 kW (359 HP)



# Introducing the New Productive Wheel Loaders:

# ZW Series

Top-Class Production with High Dependability

### High Productivity

- Computer-controlled engine
- Improved rimpull control and acceleration
- Power mode and fuel-efficient mode
- Advanced hydraulic cooling fan
- Torque proportional differential (TPD)
- Load-sensing hydraulic steering system
- Idle management system
- Outboard wet disc brakes
- Limited slip differential (LSD) (Optional)
- Lock-up torque converter (Optional)
- Efficient loading system (ELS)

Page 4-5

### Comfortable Cab

- High visibility
- ROPS/FOPS standards
- Full-auto air conditioner/heater
- Single shift lever
- Fully adjustable suspension seat
- Machine operation diagnostic module (MODM)
- Assortment of accessories
- Directional switch (Optional)
- Down-shift switch
- Adjustable steering column
- Adjustable clutch cut-off timing
- Lift arm auto-leveler
- Shift hold switch (Optional)

Page 6-7

### High Durability and Dependability

- Strong lift arms and bucket
- Sealed bucket hinge pins
- Buffer rings for hydraulic cylinders
- Extended greasing intervals of universal joints
- Full box-section track frame
- Wet disc parking brakes
- Ride control system

Page 8

### Easy Maintenance

- Easy access to engine and filters
- Halogen head lights
- LED Brake and tail lights (Optional)
- DT connectors

Page 9

### Specifications

Page 10-12



Note : Pictures may or may not include standard and optional equipment specified individually by country.



# Extra Power and Performance for Top-Class Productivity

## Computer-Controlled Engine



The Engine Control Module (ECM) provides essential operating data for efficient fault diagnosis and troubleshooting. The Cummins diagnosis tools also provide key engine data for quick, accurate analysis. The Cummins In-Line Combustion Solution, provided to meet the EPA Tier III and EU Stage III A Emission Regulation, makes engine design simple, and permits economical maintenance.

## Improved Rimpull Control and Acceleration

The powertrain is designed for more efficient operation in various applications. Improved torque control and matching between engine and torque converter deliver higher performance.

## Power Mode and Fuel-Efficient Mode

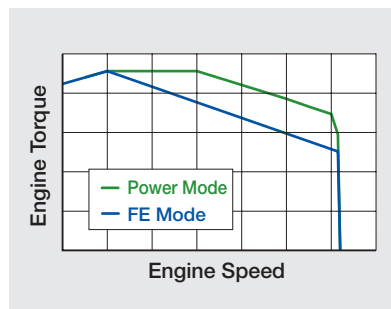

There are two engine modes — Power mode and Fuel-Efficient mode. Select the Power mode to boost power for higher production, and the Fuel-Efficient mode for fuel economy.

## Advanced Hydraulic Cooling Fan

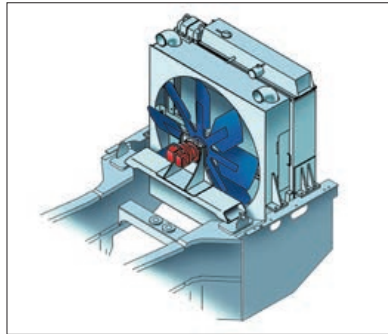

Hydraulic cooling fan speed varies with changes in operating temperatures to reduce noise and fuel consumption. The automatic reversible fan comes standard with a manual override that swings open for easy cleaning of radiators.

## Torque Proportional Differential [TPD]

The Torque Proportional Differential (TPD) adjusts torque to both wheels. When road resistances under both wheels are different, the TPD prevents the slippage of a wheel on softer ground, unlike conventional differentials. This feature allows the ZW370 to easily get out of swamps and rough terrains.

## Load-Sensing Hydraulic Steering System

The load-sensing hydraulic steering system boosts steering force, when needed, in the main hydraulic circuit. This makes possible the full use of pump torque for higher job efficiency.

## Idle Management System

The idle management system keeps engine speed low during long-time idling for fuel saving. This system also increases engine speed for quick warming-up of the ZW370 in cold weather.

## Outboard Wet Disc Brakes



The outboard-mounted, sealed wet disc brakes produce plenty of braking force, and keep out dirt. Dual lines are independently provided for front and rear axles for added safety.

## Limited Slip Differential [LSD] (Optional)

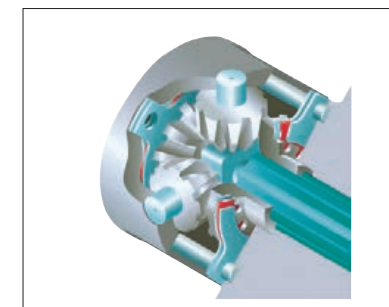

The Limited Slip Differential (LSD) effectively yields big traction force to suit job needs.

## Lock-Up Torque Converter (Optional)

The lock-up clutch in the torque converter allows direct drive in the top speed range. This remarkably increases fuel efficiency in long haul, load-and-carry operation, and hill climbing.

## Efficient Loading System [ELS]

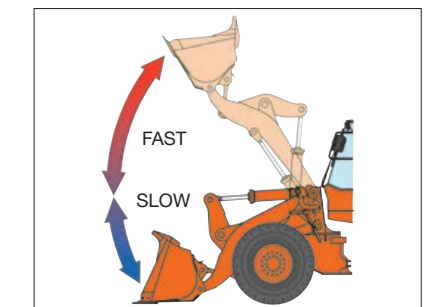

The Efficient Loading System (ELS) can increase traction force during digging while reducing fuel consumption. This achieves more production with less fuel.







## Comfortable

### Single Shift Lever

The single shift lever with twist grip is provided on the steering column for the convenience of handling.

### Directional Switch (Optional)



The directional switch is located next to control levers for easy travel direction changing. The operator does not need to left hand off the steering wheel.

### Adjustable Clutch Cut-off Timing

Clutch cut-off timing can be adjusted to suit job needs, like efficient operation on level ground, and surefooted operation on gradient.

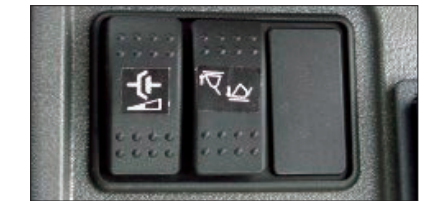

### Fully Adjustable Suspension Seat



The suspension seat is fully adjustable for riding comfort, reducing operator fatigue and increasing operator's productivity.

### Down-Shift Switch

The down-shift switch, mounted on the lift arm control lever, allows the operator to make easy downshifting from the 2nd to 1st gear.

### Lift Arm Auto-Leveler

The lift arm can be automatically raised and lowered to the preset level. High and low lift arm kickouts can be programmed, using switches inside the cab.

### High Visibility



The cab gives good visibility with inside and outside rear view mirrors. The front windshield is a flat glass mounted with rubber gaskets for easy replacement. The cab rests on viscous mounting to absorb shocks and noise for operator comfort.

### ROPS/FOPS Standards



This ROPS/FOPS cab is adopted to protect the operator from injury in the case of an accident.

*ROPS: Roll-Over Protective Structure, ISO3471*

*FOPS: Falling Object Protective Structure, ISO3449*

### Full-Auto Air Conditioner/Heater

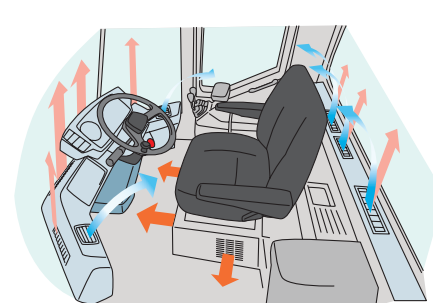

The air conditioner/heater is controlled automatically and thermostatically to enhance operator comfort. Air vents promote good air circulation inside, and defrosting all the year around. The cab is pressurized to keep out dirt.

### Machine Operation Diagnostic Module [MODM]



The Machine Operation Diagnostic Module (MODM) delivers important operating data for efficient operation, maintenance and troubleshooting.

### Adjustable Steering Column

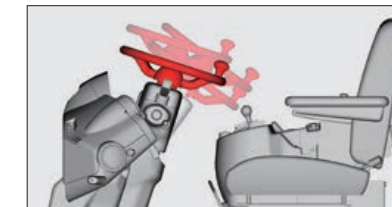

The steering column is tiltable and telescopic to suit operator's build for comfortable positioning and operation.

### Shift Hold Switch (Optional)

The shift hold switch, located on the control lever, allows the operator to hold the transmission in the current range when in the auto mode.

### Assortment of Accessories

An assortment of accessories, including radio, glove box, cup holder and storage compartment, are conveniently located inside.



## Durable and Dependable

### Strong Lift Arms and Bucket



The strong lift arms and linkage yield high production during digging, loading and hauling. Big bucket breakout force and optimum bucket rollback bring about high production and good load retention. Buckets are designed and shaped for efficient scooping-up and loading. Bolt-on cutting edges are easy to replace. The bucket leveler and boom kickout come standard.

### Sealed Bucket Hinge Pins



The bucket hinge pins are hermetically sealed to retain grease inside for longer service life.

### Buffer Rings for Hydraulic Cylinders

Hydraulic cylinders utilize buffer rings for better sealing with less leakage.

### Extended Greasing Intervals of Universal Joints



Universal joints are hermetically sealed to extend greasing intervals up to 12 000 hours, simplifying maintenance and increasing durability.

### Full Box-Section Track Frame

The track frame is box-section structured to resist twisting loads.

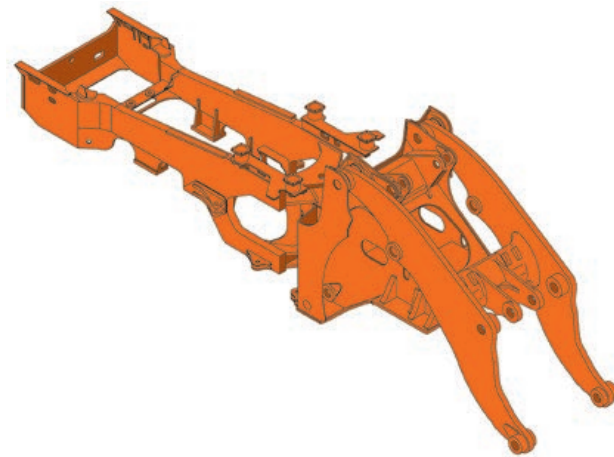

### Ride Control System

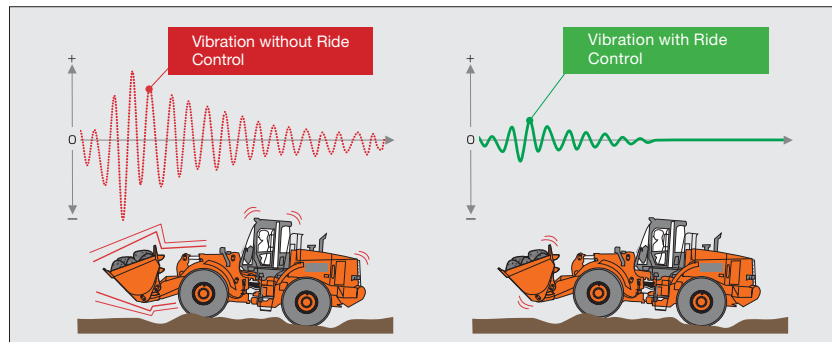

The ride control system can reduce pitching and bouncing when traveling on rough terrain and snow road. This system automatically controls the implement to reduce shocks and vibration.

### Wet Disc Parking Brake

The advanced wet disc parking brake is utilized for dependable braking.

## Easy Access for Quick Servicing



### Easy Access to Engine and Filters

Machine covers open wide for easy access to the engine and filters for efficient servicing and inspection. Filters and grease fittings are grouped for the convenience of replacement and lubrication.

### Halogen Head Lights



Front and rear working lights are bright halogen lamps for safer night-shift operation.

### LED Brake and Tail Lights (Optional)



The rear tail lights are long-life LED lamps that are very bright and durable.

### DT Connectors

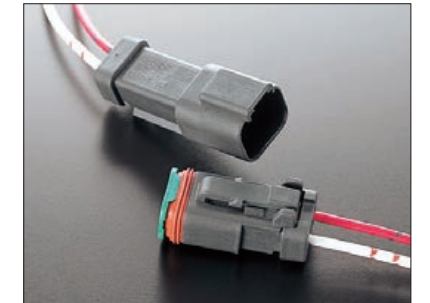

Sealed Deutsch DT connectors are used throughout the electrical system to reduce corrosion and ensure positive connection.

# SPECIFICATIONS

## ENGINE

Model.....	Cummins QSX15
Type .....	4-cycle water-cooled, direct injection
Aspiration.....	Turbocharger and intercooled
No. of cylinders .....	6
Maximum power	Net
ISO 9249, net.....	268 kW (359 HP) at 2 000 min <sup>-1</sup> (rpm)
Bore and stroke.....	137 mm X 169 mm
Piston displacement....	14.95 L
Batteries.....	2 X 12 V / 1 146 CCA, 140 Ah
Air cleaner .....	Two element dry type with restriction indicator

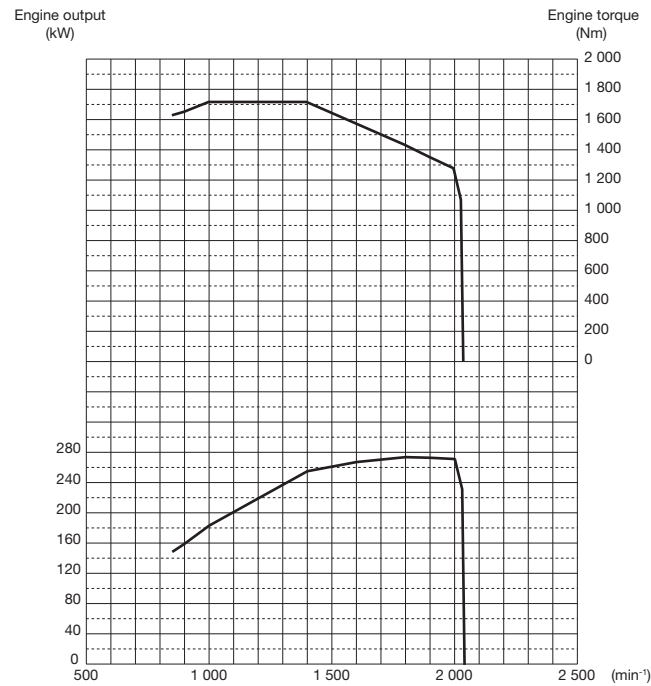

## POWER TRAIN

Transmission .....	Torque converter, planetary gear type powershift with computer-controlled automatic shift and manual shift features included.
Torque converter .....	Three element, single stage, single phase
Main clutch .....	Wet hydraulic, multi-disc type
Cooling method.....	Forced circulation type
Travel speed* (km/h)	Forward / Reverse
1st .....	7.7 / 8.3
2nd .....	14.5 / 15.6
3rd .....	24.4 / 26.1
4th .....	34.8 / -

\*With 29.5-R25 (L3) tires

## AXLE AND FINAL DRIVE

Drive system .....	Four-wheel drive system
Front & rear axle.....	Full-floating
Front .....	Fixed to the front frame
Rear .....	Trunnion support
Reduction and differential gear .....	Spiral bevel gear with torque proportional differential
Oscillation angle .....	Total 24° (+12°, -12°)
Final drives .....	Heavy-duty planetary, mounted outboard

## TIRES

Tire size.....	29.5-R25 (L3)
----------------	---------------

## BRAKES

Service brakes .....	Outboard mounted fully hydraulic 4 wheel wet disc brake. Front & rear independent brake circuit.
----------------------	--

## STEERING SYSTEM

Type .....	Articulated frame steering
Steering mechanism....	Completely hydraulic power steering
Steering angle .....	Each direction 40° ; total 80°
Cylinders .....	Two double-acting piston type
No. x Bore x Stroke...	2 x 90 mm x 600 mm
Minimum turning radius at the centerline of outside tire .....	6 160 mm

## HYDRAULIC SYSTEM

Lift arm and bucket are controlled by independent control lever.	
Lift arm controls .....	Four position valve ; Raise, hold, lower, float
Bucket controls with automatic bucket return-to-dig control.....	Three position valve ; Roll back, hold, dump
Main pump / Steering pump ...	Fixed displacement type gear pump
Charging pump / Fan pump / Brake and assist pump.....	Fixed displacement type gear pump
Hydraulic cylinders	
Type .....	Two lift arm and two bucket, double acting type
No. x Bore x Stroke..	Arm : 2 x 190 mm x 953 mm Bucket : 2 x 160 mm x 605 mm
Filters .....	Full-flow 28 micron return filter in reservoir
Hydraulic cycle times	
Lift arm raise.....	6.1 s
Lift arm lower.....	4.0 s
Bucket dump.....	1.5 s
Total .....	11.6 s

## SERVICE REFILL CAPACITIES

Fuel tank .....	465.0	liters
Engine coolant .....	100.0	
Engine oil .....	50.0	
Torque convertor & transmission .....	70.0	
Front axle differential & wheel hubs.....	100.0	
Rear axle differential & wheel hubs .....	100.0	
Hydraulic reservoir tank .....	150.0	

## BUCKET SELECTION GUIDE

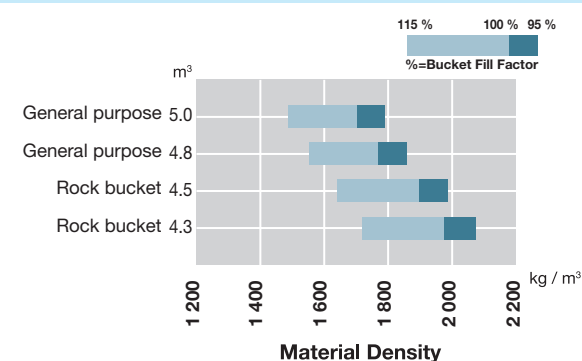

## DIMENSIONS & SPECIFICATIONS

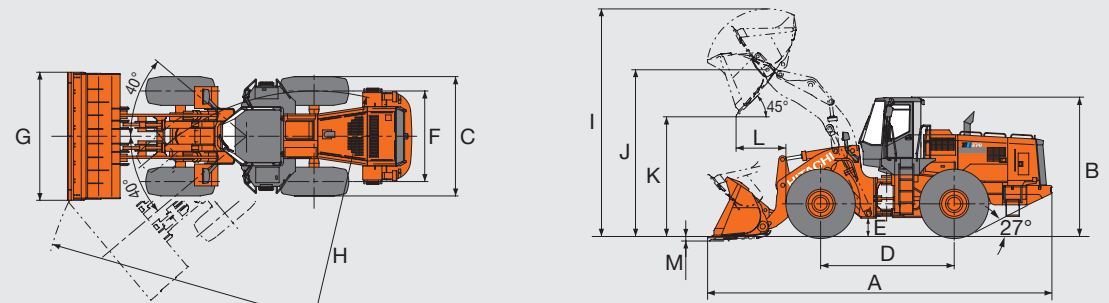

Equipped with general purpose bolt-on edges 5.0 m<sup>3</sup> bucket, 29.5-R25 (L3) tubeless tire and ROPS cab.

Arm type	Standard arm						
	General purpose		Rock bucket		Coal bucket		
	Round bottom		Straight edge	V-edge	Round bottom		
Bucket type	With bolt-on cutting edges		With bolt-on teeth	With bolt-on teeth	With bolt-on teeth		
	With bolt-on cutting edges	With bolt-on teeth	With bolt-on teeth	With bolt-on teeth	With bolt-on cutting edges		
Bucket capacity	ISO heaped m <sup>3</sup>	5.0	4.8	4.3	4.5	7.5	
	ISO struck m <sup>3</sup>	4.3	4.1	3.7	3.8	6.4	
A Overall length	mm	9 280	9 420	9 420	9 600	9 410	
B Overall height (Top of cab)	mm	3 760					
C Width over tires	mm	3 220					
D Wheel base	mm	3 600					
E Ground clearance	mm	500					
F Tread	mm	2 440					
G Bucket width	mm	3 450	3 465	3 465	3 465	4 090	
H Turning radius (Centerline of outside tire)	mm	6 160					
H' Loader clearance circle, bucket in carry position	mm	7 335	7 380	7 380	7 380	7 660	
I Overall operating height	mm	6 130	6 130	6 190	6 190	6 415	
J Height to bucket hinge pin, fully raised	mm	4 490					
K Dumping clearance 45 degree, full height	mm	3 220	3 105	3 100	2 970	3 135	
L Reach, 45 degree dump, full height	mm	1 350	1 420	1 425	1 550	1 430	
M Digging depth (Horizontal digging angle)	mm	80	110	110	110	80	
Bucket weight	kg	2 760	2 590	3 050	3 180	3 320	
Static tipping load *	Straight	kg	24 260	24 420	23 980	23 640	23 060
	Full 40 degree turn	kg	19 960	20 100	19 740	19 460	18 980
Breakout force		kN	245	265	265	226	223
		(kgf)	(25 000)	(27 000)	(27 000)	(23 100)	(22 800)
Operating weight *	kg	30 950	30 770	31 240	31 360	31 510	

Note:1. All dimensions, weight and performance data based on ISO 6746-1:1987, ISO 7137:1997 and ISO 7546:1983

2. Static tipping load and operating weight marked with \* include 29.5-R25 (L3) tires (No ballast) with lubricants, counterweight, full fuel tank and operator.

Machine stability and operating weight depend on counterweight, tire size and other attachments.

## WEIGHT CHANGE

Option item	Operating weight kg	Tipping load kgf		Overall width mm (outside tire)	Overall height mm	Overall length mm
		Straight	Full turn			
26.5R25 (L3)	-680	-520	-420	-90	-50	+40
26.5R25 (L4)	-280	-210	-170	-60	-20	+20
26.5R25 (L5)	+60	+40	+30	-60	-10	+10
29.5R25 (L3)	±0	±0	±0	±0	±0	±0
29.5R25 (L4)	+500	+380	+310	+10	+35	-30
29.5R25 (L5)	+840	+640	+530	+10	+40	-40
26.5-25-24PR (L3)	-420	-320	-260	-90	-50	+40
26.5-25-24PR (L4)	-20	-10	-10	-60	-20	+20
26.5-25-24PR (L5)	+570	+430	+350	-60	-10	+10
29.5-25-22PR (L3)	±0	±0	±0	±0	±0	±0
29.5-25-22PR (L4)	+730	+560	+460	+10	+35	-30
29.5-25-22PR (L5)	+1 080	+830	+680	+10	+40	-40
Under guard	+230	+390	+320	—	—	—



# EQUIPMENT

## STANDARD EQUIPMENT

Standard equipment may vary by country, so please consult your Hitachi dealer for details.

### ELECTRICAL

- Alternator, 75 ampere and 24 volts
- Back up alarm
- Brake and tail lights
- Electric starter
- Halogen headlights with high and low beams (2 front)
- Halogen working lights (4 front and 4 rear)
- Turn signals with four-way flasher

### GAUGES AND INDICATORS

- Air cleaner warning lamp
- Auto shift indicator lamp
- Battery charge lamp
- Brake pressure warning lamp
- Engine coolant temperature gauge and warning lamp
- Engine oil pressure warning lamp
- Fuel level gauge
- High beam indicator lamp
- Hour meter
- Neutral indicator lamp
- Parking brake indicator lamp
- Tachometer
- Torque converter oil temperature gauge and warning lamp
- Transmission control warning lamp
- Transmission clutch cut-off lamp
- Transmission status monitor
- Working light indicator lamp

### OPERATOR ENVIRONMENT

- Adjustable operator seat with mechanical suspension
- Ashtray
- Cigarette lighter
- Coat hook
- Cup holder
- Down-shift switch
- Electric dual horns
- Front and rear wiper and washers
- Full automatic air conditioner
- Lockable doors with sliding windows by regulator handles (left and right)
- Machine Operation Diagnostic Module (MODM)
- Rear view mirrors (interior and exterior)
- ROPS/FOPS cab (left and right doors open, walk-through design)
- Rubber floor mat
- Seat belt
- Storage compartment
- Sun visor
- Telescopic and tilt steering wheel
- Tinted safety glass (laminated glass)
- Transmission clutch cut-off adjust switch
- Two-lever for two-spool control valve

### POWER TRAIN

- Air filter double elements
- Automatic reversible hydraulic operated cooling fan
- Auto shift transmission
- Cummins QSX15 diesel engine
- Extended greasing intervals of universal joints
- Full hydraulic enclosed wet multi-disc brakes
- Pre-air cleaner
- Ride control system, speed sensitive automatic
- Tires, 29.5-R25 (L3)
- Torque proportioning differentials (front/rear)

### OTHERS

- Bucket auto leveler
- Drawbar, with rocking pin
- Efficient loading system (ELS)
- Handrails
- Ladders, left and right
- Lift arm auto leveler
- Loading linkage, sealed Z-bar type dual cylinders
- Mud guard for front fenders
- Power & Fuel efficient mode
- Secondary brake
- Vandalism protection kit
- Wet disc parking brake

### BUCKET

- General purpose bucket with bolt-on cutting edges: 5.0 m<sup>3</sup> (ISO heaped)

## OPTIONAL EQUIPMENT

Optional equipment may vary by country, so please consult your Hitachi dealer for details.

### OPERATOR ENVIRONMENT

- Adjustable operator seat with air suspension
- AM/FM radio
- Directional switch
- Head rest
- Three-spool main control valve with three levers
- Two-spool main control valve with mono lever

### POWER TRAIN

- Auto shift transmission with lock up torque converter
- Brake and tail lights (LED)
- Emergency steering system
- Limited slip differential (LSD)
- Shift hold switch

### OTHERS

- Bucket cylinder guard
- Front wide fender and mud guard
- Full rear fender and mud guard
- High lift arm
- Under guard

### BUCKET

- Coal bucket with bolt-on cutting edges: 7.5 m<sup>3</sup> (ISO heaped)
- General purpose bucket for high lift arm with bolt-on edge: 4.2m<sup>3</sup> (ISO heaped)
- General purpose bucket with bolt-on teeth: 4.8 m<sup>3</sup> (ISO heaped)
- Rock bucket (straight edge) with weld-on teeth: 4.3 m<sup>3</sup> (ISO heaped)
- Rock bucket (V-edge) with weld-on teeth: 4.5 m<sup>3</sup> (ISO heaped)

These specifications are subject to change without notice.

Illustrations and photos show the standard models, and may or may not include optional equipment, accessories, and all standard equipment with some differences in color and features.

Before use, read and understand the Operator's Manual for proper operation.

Note : \* : ROPS (Roll Over Protective Structure) Conforms to ISO 3471;1994

\*\* : FOPS (Falling Objects Protective Structure) Conforms to ISO 3449; 1992 Level II